



## 2N7002

Power MOSFET

### 0.3 Amps, 60 Volts N-CHANNEL POWER MOSFET

#### DESCRIPTION

The UTC **2N7002** has been designed to minimize on-state resistance while provide rugged, reliable, and fast switching performance. It can be used in most applications requiring up to 400mA DC and can deliver pulsed currents up to 2A. The product is particularly suited for low voltage, low current applications such as small servo motor control, power MOSFET gate drivers, and other switching applications

#### FEATURES

- \* High Density Cell Design for Low  $R_{DS(ON)}$ .
- \* Voltage Controlled Small Signal Switch
- \* Rugged and Reliable
- \* High Saturation Current Capability

#### SYMBOL

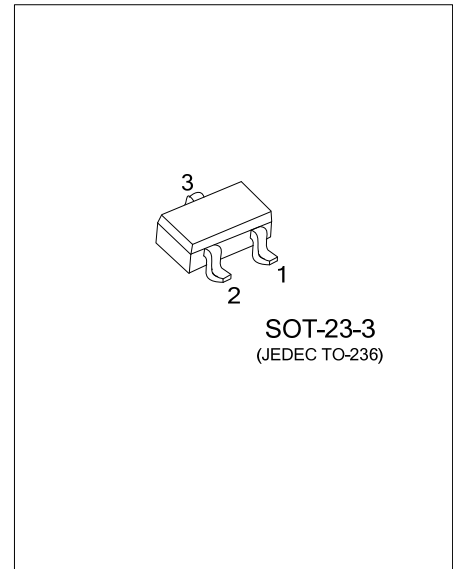
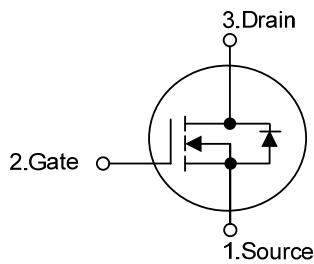

#### ORDERING INFORMATION

Ordering Number		Package	Pin Assignment			Packing
Lead Free	Halogen Free		1	2	3	
2N7002L-AE2-R	2N7002G-AE2-R	SOT-23-3	S	G	D	Tape Reel

2N7002G-AE2-R	(1)Packing Type	(1) R: Tape Reel
	(2)Package Type	(2) AE2: SOT-23-3
	(3)Halogen Free	(3) G: Halogen Free, L: Lead Free

#### MARKING

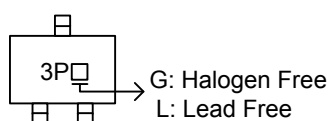

■ ABSOLUTE MAXIMUM RATINGS (Ta=25°C unless otherwise noted.)

PARAMETER	SYMBOL	RATINGS	UNIT
Drain-Source Voltage	V <sub>DSS</sub>	60	V
Drain-Gate Voltage (R <sub>GS</sub> ≤ 1MΩ)	V <sub>DGR</sub>	60	V
Gate Source Voltage	V <sub>GSS</sub>	±20	V
		±40	
Drain Current	I <sub>D</sub>	300	mA
		800	
Power Dissipation Derated Above 25°C	P <sub>D</sub>	200 1.6	mW mW/°C
Junction Temperature	T <sub>J</sub>	+ 150	°C
Storage Temperature	T <sub>STG</sub>	-55 ~ +150	°C

Note: Absolute maximum ratings are those values beyond which the device could be permanently damaged.

Absolute maximum ratings are stress ratings only and functional device operation is not implied.

■ THERMAL CHARACTERISTICS

PARAMETER	SYMBOL	RATINGS	UNIT
Junction to Ambient	θ <sub>JA</sub>	625	°C/W

■ ELECTRICAL CHARACTERISTICS (T<sub>A</sub>=25°C, unless otherwise specified)

PARAMETER	SYMBOL	TEST CONDITIONS	MIN	TYP	MAX	UNIT
<b>OFF CHARACTERISTICS</b>						
Drain-Source Breakdown Voltage	BV <sub>DSS</sub>	V <sub>GS</sub> =0V, I <sub>D</sub> =10μA	60			V
Drain-Source Leakage Current	I <sub>DSS</sub>	V <sub>DS</sub> =60V, V <sub>GS</sub> =0V			1	μA
Gate-Source Leakage Current	I <sub>GSSF</sub>	V <sub>GS</sub> =20V, V <sub>DS</sub> =0V			100	nA
		V <sub>GS</sub> =-20V, V <sub>DS</sub> =0V			-100	nA
<b>ON CHARACTERISTICS (Note)</b>						
Gate Threshold Voltage	V <sub>GS(TH)</sub>	V <sub>GS</sub> = V <sub>DS</sub> , I <sub>D</sub> =250μA	1	2.1	2.5	V
Drain-Source On-Voltage	V <sub>DS(ON)</sub>	V <sub>GS</sub> = 10V, I <sub>D</sub> =500mA		0.6	3.75	V
		V <sub>GS</sub> = 5.0V, I <sub>D</sub> =50mA		0.09	1.5	
On-State Drain Current	I <sub>D(ON)</sub>	V <sub>GS</sub> =10V, V <sub>DS</sub> ≥2V <sub>DS(ON)</sub>	500	2700		mA
Static Drain-Source On-Resistance	R <sub>DS(ON)</sub>	V <sub>GS</sub> = 10V, I <sub>D</sub> =500mA			7.5	Ω
		V <sub>GS</sub> = 5.0V, I <sub>D</sub> =50mA			7.5	Ω
<b>DYNAMIC CHARACTERISTICS</b>						
Input Capacitance	C <sub>ISS</sub>	V <sub>DS</sub> =25V, V <sub>GS</sub> =0V, f=1.0MHz		20	50	pF
Output Capacitance	C <sub>OSS</sub>			11	25	pF
Reverse Transfer Capacitance	C <sub>RSS</sub>			4	5	pF
Turn-On Time	t <sub>ON</sub>	V <sub>DD</sub> =30V, R <sub>L</sub> =150Ω I <sub>D</sub> =200mA, V <sub>GS</sub> =10V R <sub>GEN</sub> =25Ω			20	nS
Turn-Off Time	t <sub>OFF</sub>	V <sub>DD</sub> =30V, R <sub>L</sub> =25Ω I <sub>D</sub> =200mA, V <sub>GS</sub> =10V R <sub>GEN</sub> =25Ω			20	nS
<b>DRAIN-SOURCE DIODE CHARACTERISTICS AND MAXIMUM RATINGS</b>						
Drain-Source Diode Forward Voltage	V <sub>SD</sub>	V <sub>GS</sub> =0V, I <sub>S</sub> =115mA (Note )		0.88	1.5	V
Maximum Pulsed Drain-Source Diode Forward Current	I <sub>SM</sub>				0.8	A
Maximum Continuous Drain-Source Diode Forward Current	I <sub>S</sub>				115	mA

Note: Pulse Test: Pulse Width ≤ 300μs, Duty Cycle ≤ 2.0%

■ TEST CIRCUIT AND WAVEFORM

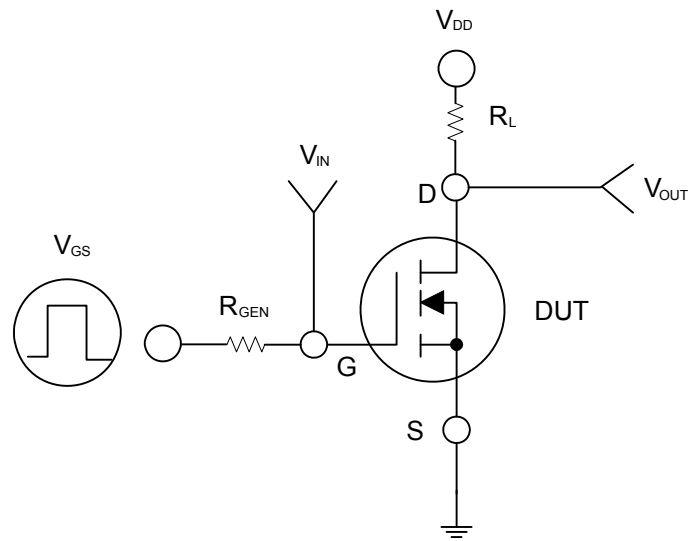

Figure 1

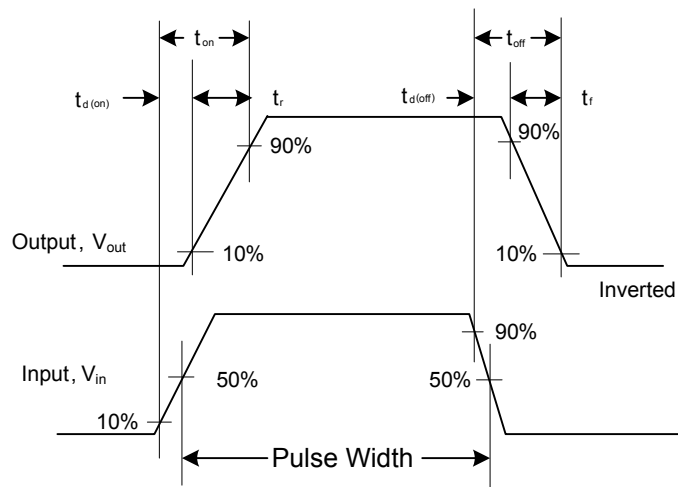
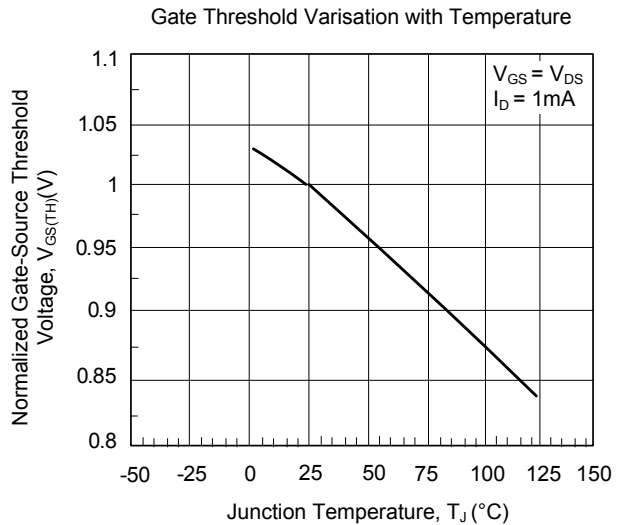
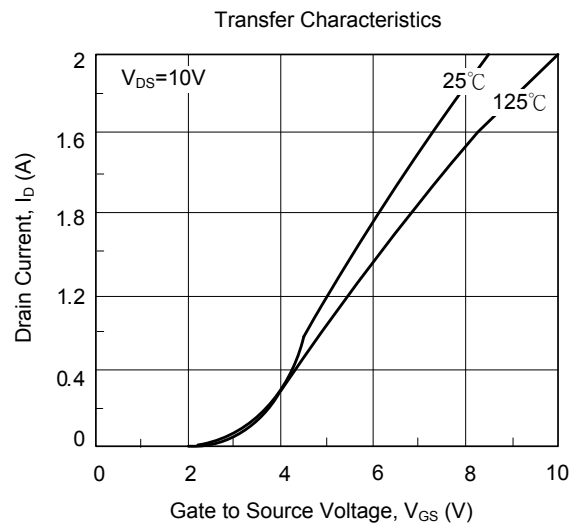
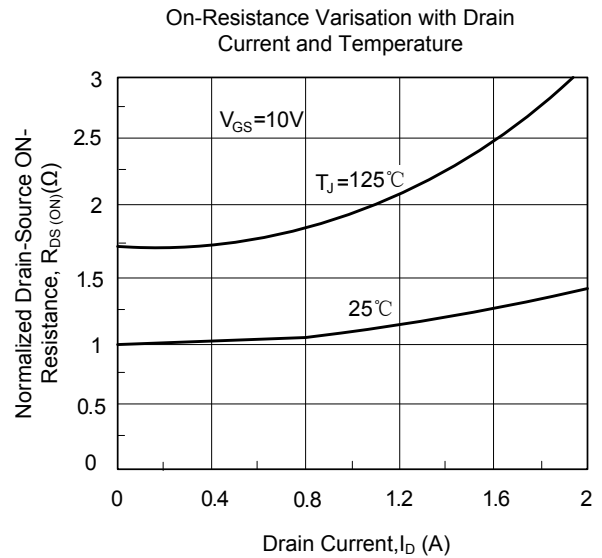
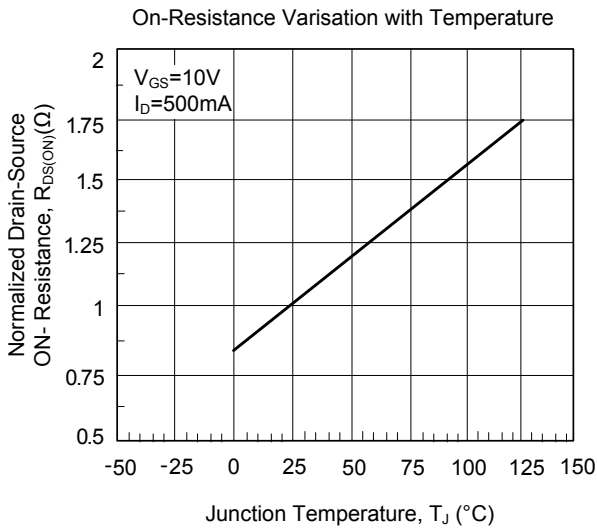
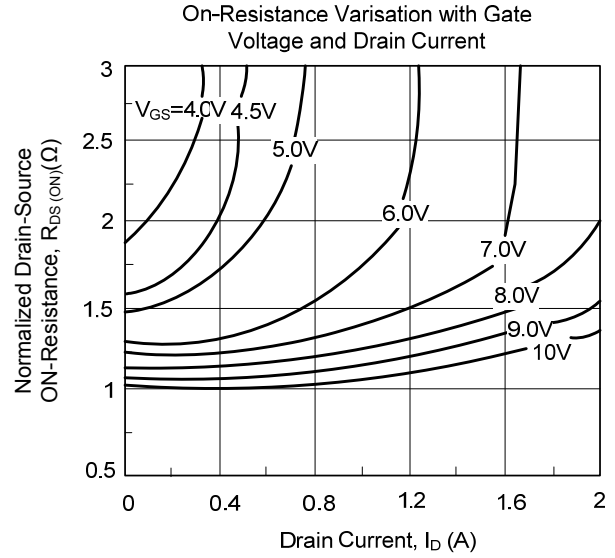
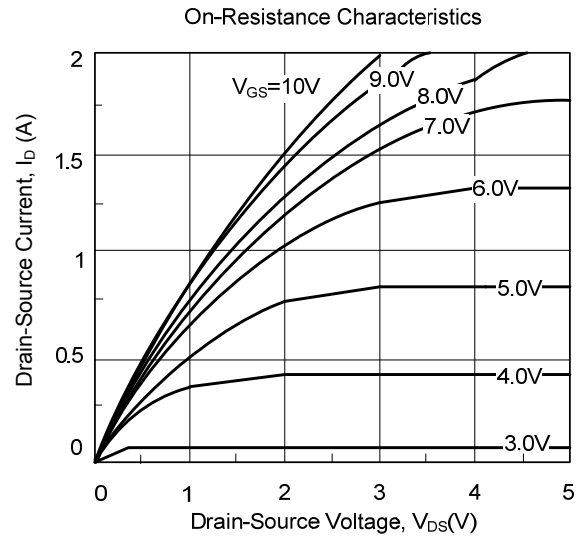

Figure 2. Switching Waveforms

■ TYPICAL CHARACTERISTICS



## TYPICAL CHARACTERISTICS (Cont.)

Breakdown Voltage Variation with Temperature

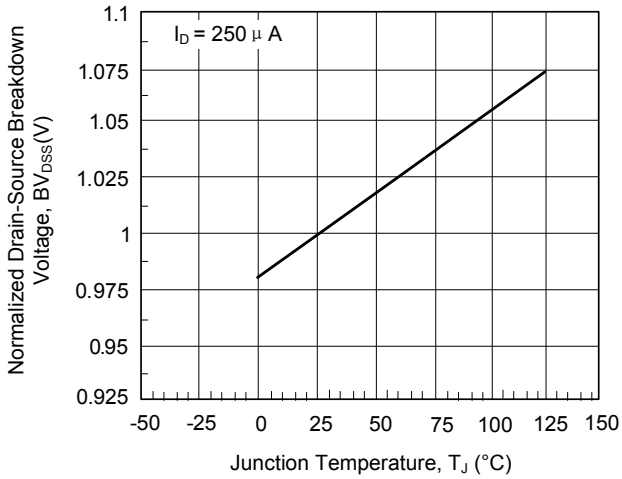

Body Diode Forward Voltage Variation with Temperature

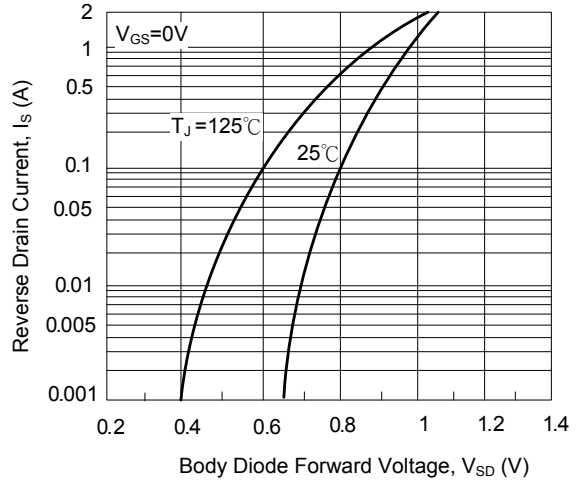

Capacitance Characteristics

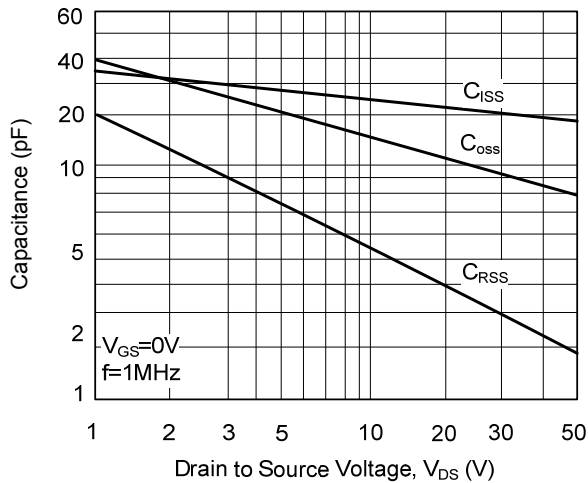

Gate Charge Characteristics

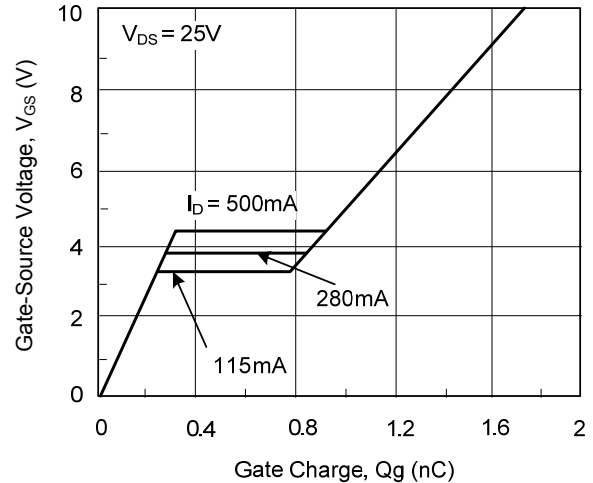

Maximum Safe Operating Area

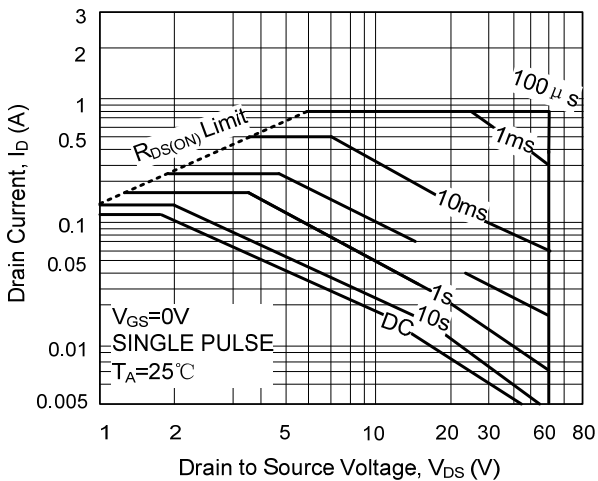

Transient Thermal Response Curve

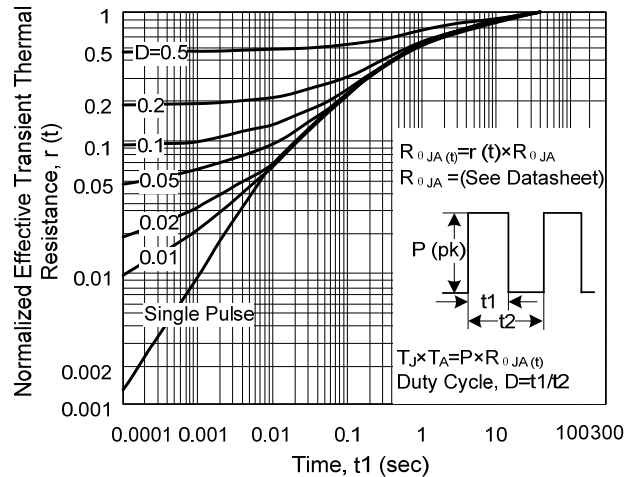

UTC assumes no responsibility for equipment failures that result from using products at values that exceed, even momentarily, rated values (such as maximum ratings, operating condition ranges, or other parameters) listed in products specifications of any and all UTC products described or contained herein. UTC products are not designed for use in life support appliances, devices or systems where malfunction of these products can be reasonably expected to result in personal injury. Reproduction in whole or in part is prohibited without the prior written consent of the copyright owner. The information presented in this document does not form part of any quotation or contract, is believed to be accurate and reliable and may be changed without notice.